

week9 / PLC_1 [CPU 1212C AC/DC/Rly] / Program blocks

Main [OB1]

Main Properties

General

Name	Main	Number	1	Type	OB	Language	LAD
------	------	--------	---	------	----	----------	-----

Numbering	Automatic
-----------	-----------

Information

Title	"Main Program Sweep (Cycle)"	Author		Comment		Family	
-------	------------------------------	--------	--	---------	--	--------	--

Version	0.1	User-defined ID	
---------	-----	-----------------	--

Main

Name	Data type	Default value	Supervision	Comment
▼ Input				
Initial_Call	Bool			Initial call of this OB
Remanence	Bool			=True, if remanent data are available
Temp				
Constant				

Network 1:

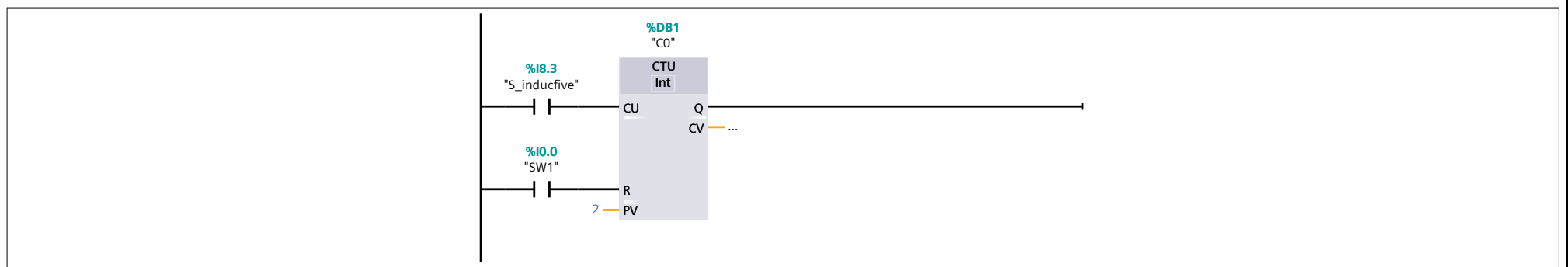

Network 2:

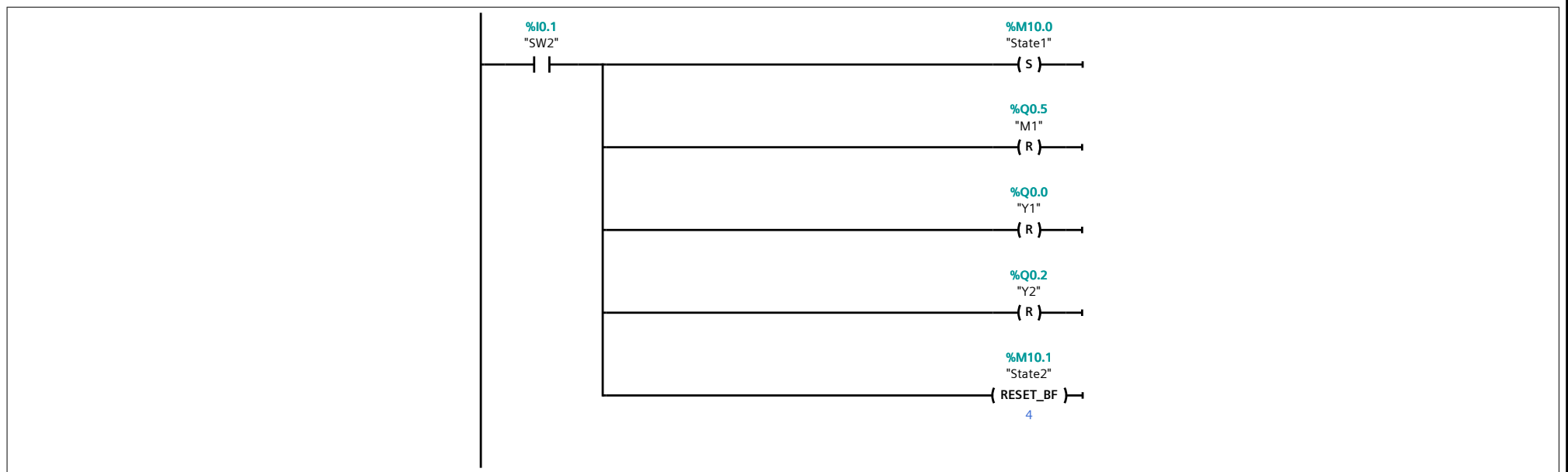

Network 3:

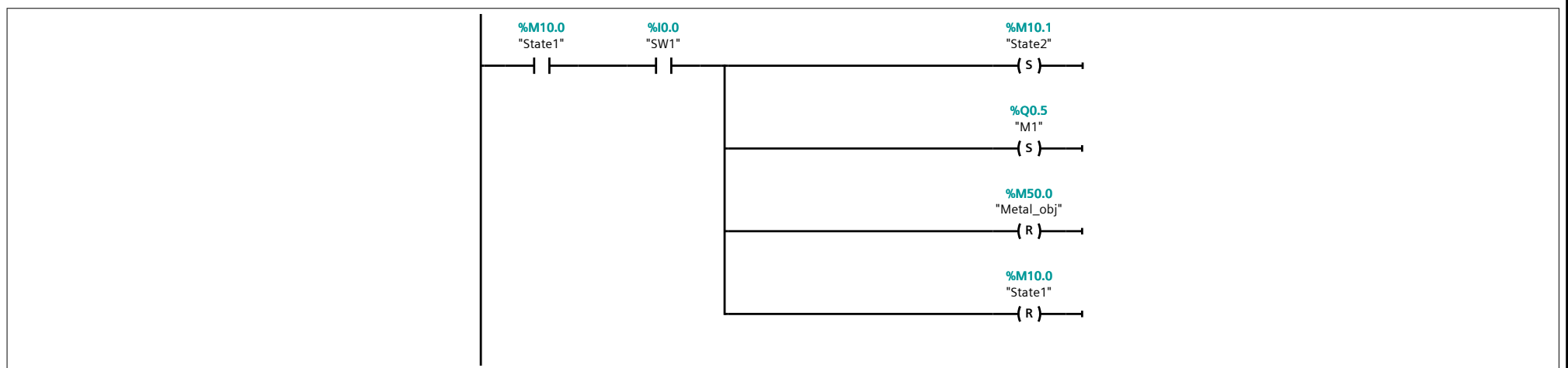

Network 4:



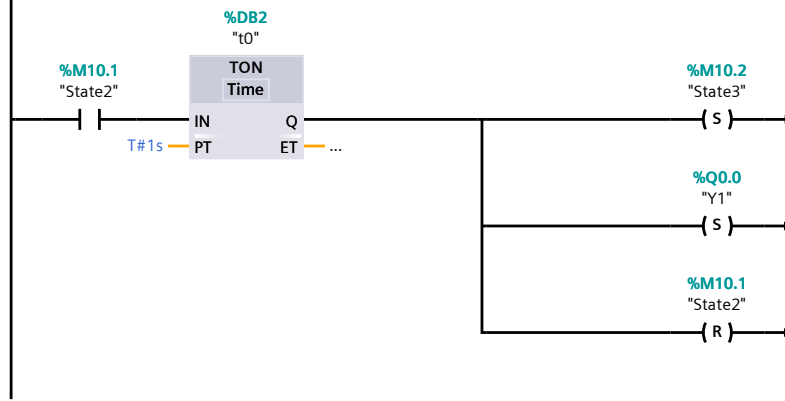

Network 5:

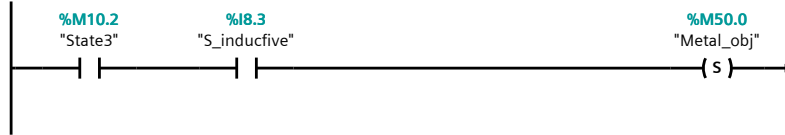

Network 6:

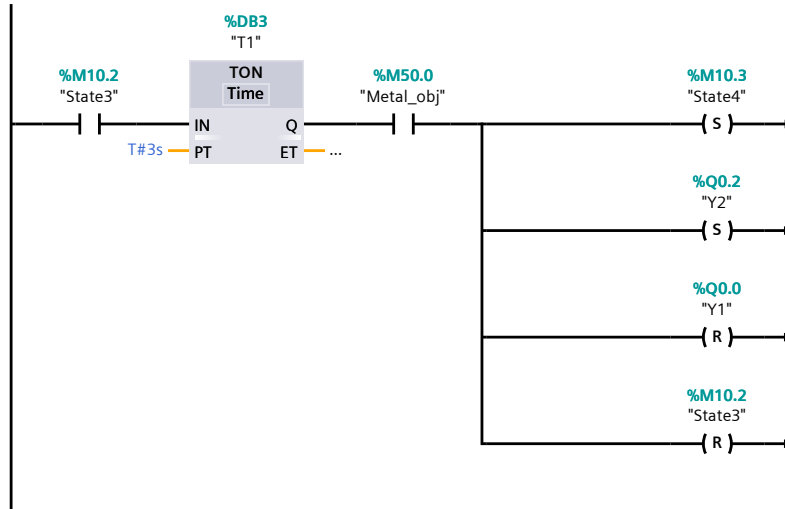

Network 7:

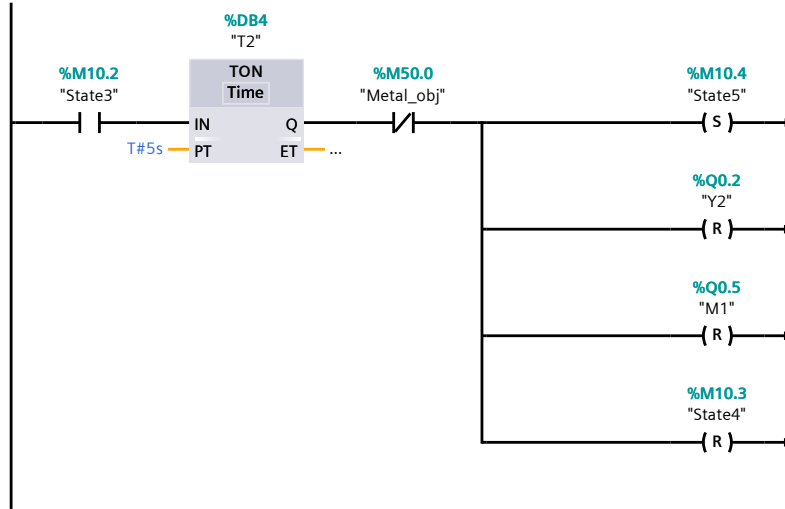

Network 8:

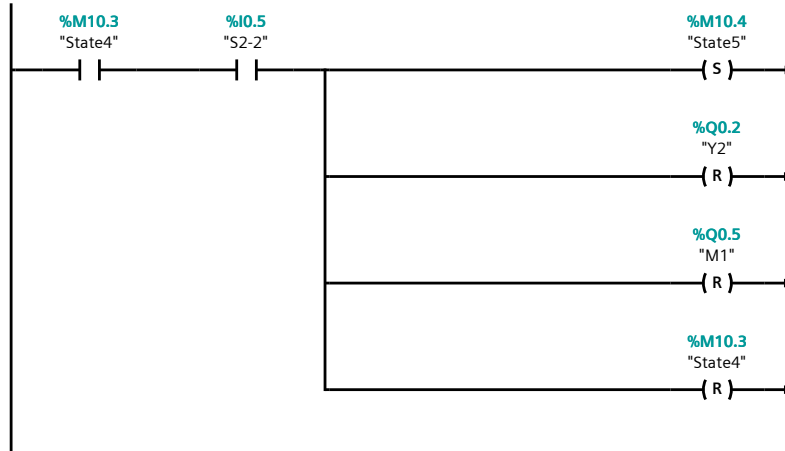

Network 9:

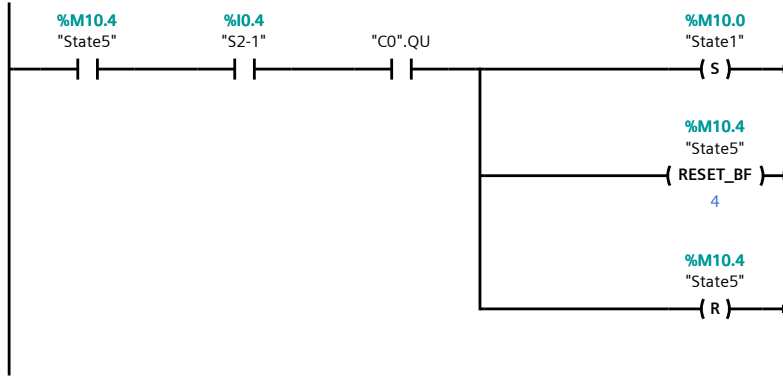

Network 10:

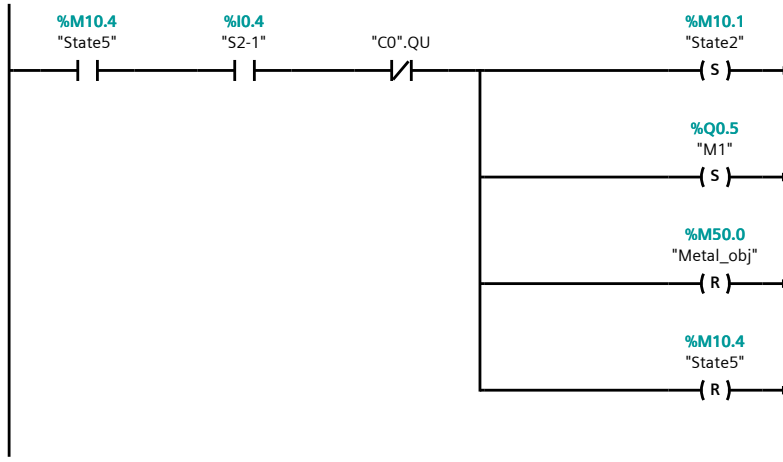

Network 11:

